

# bernette

SWISS DESIGN



# SEWING MACHINES



**BERNETTE SEWING MACHINE WORKBOOK**

For bernette models sew&go, b33 and b35

# TABLE OF CONTENTS

Introduction.....	3
Sewing Machine Needles.....	4
Thread.....	6
bernette Presser Feet .....	7
Selecting Stitches.....	8
Turning Corners.....	9
Zigzag Stitch .....	10
Blind Hem .....	11
4-Step Buttonhole .....	12
1-Step Buttonhole.....	13
Attaching Buttons.....	14
Stitching Zippers.....	15
Decorative Stitching.....	16
Satin Stitching .....	17
Double Needle Stitching.....	18
Supplies.....	19
Stitch, Function, and Foot Charts.....	20



The information in this workbook applies to bernette models: sew&go, b33 and b35.

*Note: Some exercises apply only to certain models equipped with the feature being highlighted.*

# INTRODUCTION

Congratulations on the purchase of your new bernette sewing machine. The information in this workbook will help you learn the basics of using your new machine.

This workbook is designed to be used as a step-by-step guide to familiarize you with the basic operation of your bernette sewing machine. Once you have completed the exercises designated for your machine, attach the sewn samples to the information pages (or add a facing page for mounting) and insert the pages into plastic page protectors to store in a 3-ring binder. They can then be used as a reference tool in the future as you use your machine and explore the creative possibilities it affords.

Stitch and function charts for each bernette model are found on pages 20-22. Each stitch exercise page has a graphic of the stitch(es) used so you can quickly find it on the chart and then locate it on your machine.

Each page with a stitching exercise ends with a “Sew How” box. This mini-quiz will let you test your knowledge and review the points related to the exercise.

Taking the class is just the first step. Using the information on a regular basis will help make it become part of your sewing skill set.

Instructional video tutorials for these modes are available on [mybernette.com](http://mybernette.com). You will also find inspiring sewing projects and machine information on the bernette website.

[www.mybernette.com](http://www.mybernette.com)



# Sewing Machine Needles

## Needle "Secret" Code

- DRI = Triple
- E = Embroidery
- J = Jeans
- L, LL, R = Leather
- M = Microtex
- MET = Metallic
- N = Topstitching/Cor-donnet
- Q = Quilting
- S = Stretch
- SUK = Fine Ball Point
- SES = Medium Ball Point
- WING = Wing
- ZWI = Double
- ZWIHO = Double Wing

## Needle Size Conversion

Regardless of the system, the greater the number, the larger the diameter of the needle.

### European vs. Domestic

60=8	90=14
70=10	100=16
75=11	110=18
80=12	120=19

## Needle Size for Fabrics

- 60 – very fine batiste
- 70 – shirt-weight
- 80 – medium-weight
- 90 – denim and twill
- 100/110/120 – canvas

## General Information

Along with thread, needles are very important to stitch formation. Many "mechanical" problems and damage to fabrics can be traced to a bent, damaged, or incorrect size or type needle.

When selecting the correct needle, consider the following:

- Needle system – 130/705H
- Needle point – assures proper stitch formation; avoids fabric damage
- Needle size – smaller for lightweight fabrics; larger for heavier fabrics

If the needle is:

- Too small – the thread can't stay in the groove to form a loop to be picked up by the hook point
- Bent – the thread loop forms too far away from hook point and the hook can't enter the loop to form a stitch
- Blunt – the needle won't pierce fabric, so no thread loop forms to make a stitch

## Need to Know

- Needles should be changed after every 4-6 hours of stitching. The needle is the most inexpensive part in your sewing machine, but it is crucial for getting good results and keeping your machine running well.
- Don't let false economy keep you from doing what is best for your sewing projects and your machine.
- The selected thread should fit in the groove on the front of the needle. If it isn't protected by the groove, a needle with a larger groove should be used.
- Always make sure needles are fully inserted as high as possible, with the flat side to the back.

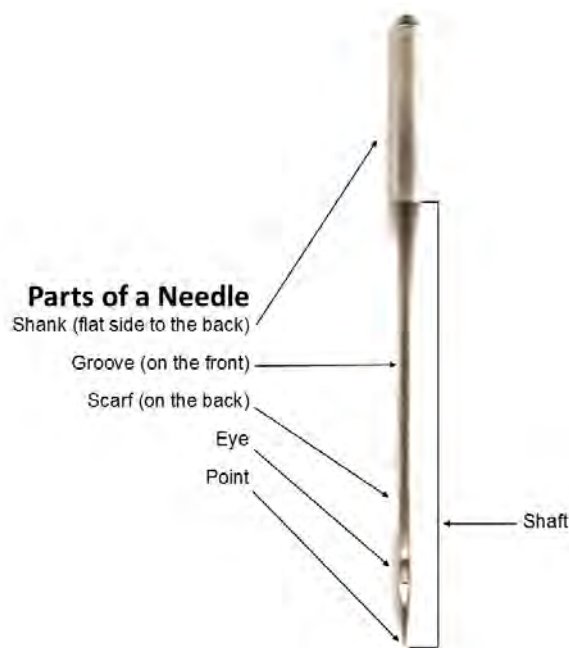

# Sewing Machine Needles

TYPE	SIZES	DESCRIPTION
Ballpoint	60 – 100	Has a rounded point. Size 70 for lingerie, nylon, jersey; 80 for t-shirt; 90 for sweatshirt fleece.
Stretch	70 – 90	A Stretch needle has a more rounded point than a Ballpoint, and a blue anti-cling coating which helps to prevent skipped stitches in knits and elastic. Sometimes used on Ultrasuede, vinyl, and plastic.
Universal	60 – 120	A compromise between a Sharp and a Ballpoint; used on both wovens and knits.
Double	1.6/70 – 8.0/100	Two needles attached to one shank. For pintucks, hems, and decorative work. Available in Universal, Stretch, Jeans, Metallic, and Embroidery needles.
Triple	2.5/90 – 3.0/90	Three needles attached to one shank. Used to create mock smocking and other decorative effects.
Jeans	70 – 110	Has a sharp point and a shaft that is less prone to flex. The sharpness of the needle is better for use on denim and woven fabrics.
Leather	80 – 100	Point is a sharp cutting wedge. Used for leather only. Not for vinyl or simulated leathers.
Microtex / Sharp	60 – 90	Sharp point; thin shaft. Specially designed for microfiber fabrics.
Quilting	75 and 90	Thin, tapered point eliminates potential damage to fabric when seaming and cross-seaming.
Topstitch	70 – 100	A sharp point with a large eye and deep groove. For use with heavier fabrics – the large groove cradles heavier threads.
Embroidery	75 and 90	Sharp needle with large eye and groove; has a coating and a larger scarf. Prevents shredding of rayon or metallic threads. Two threads may be used through the eye.
Metafil	80	Similar to Embroidery needle with large eye and deep groove. Made of a heat-resistant alloy with a friction-reducing coating. Suitable for manufactured fibers such as polyester, acrylic, and nylon.
Wing	100 and 110	Sharp-pointed needle with a non-cutting metal wedge on each side. Makes a hole without cutting the threads of the fabric. Used for decorative and heirloom work, such as hemstitching.
Double Wing	100	One Universal needle and one Wing needle attached to a single shank.
Metallic	70 – 100	Designed for metallic threads; has a large eye and deep groove.

# Thread

To achieve quality stitches, a sewing machine needs three things: suitable thread, correct needle size, and properly adjusted thread tensions. Poor quality or the wrong type of thread can cause inferior stitches on any machine. Low-quality thread results in crooked and looped stitches, puckered seams, frayed thread, and/or needle breakage. Did you know that thread passes through the eye of the needle approximately 37 times in a "seesaw" action before it forms a single stitch?

Long staple threads are stronger and smoother than short staple threads (Staple refers to the length of fibers twisted together to form a single ply.) Most bargain-priced threads are made of short staple and will deposit more lint and fuzz into your sewing machine, potentially causing tension inconsistencies and possibly even damage to your machine over the long term. Using long staple threads also results in less snagging and fraying.

Ply refers to the number of strands twisted together to make a single thread. The plies are usually indicated by a number after the weight of the thread such as 50/3, which means a 3-ply, 50 weight thread. The lower the weight, the heavier the thread; conversely, higher numbers indicate fine or light-weight thread.

## Guidelines for Thread Weights

- 12 wt.— Couching, bobbinwork
- 30 wt.— Embroidery, bobbinwork
- 40 wt.— General construction, quilting, embroidery
- 50 wt.— General construction, piecing, bobbin thread, quilting
- 60 wt.— Lingerie, heirloom, appliqué, bobbin thread, quilting
- 80 wt.— Extra-fine lingerie, heirloom

## Fibers

Fiber refers to the type of material used to produce the thread.

### Polyester

Good for clothing construction on man-made, natural, or blended fabrics. Tolerates high temperatures. Polyester embroidery thread has a high sheen; excellent for machine embroidery, abrasion resistant, and will not fade.

### Cotton

Available in a wide range of weights from 12-100, cotton thread gives a soft, full look to embroidery, applique, and buttonholes. It is also excellent for clothing construction on natural fibers, patchwork piecing, darning and heirloom sewing.

### Rayon

A glossy embroidery thread, rayon is not as strong as cotton and polyester fibers, making it useful for decorative work but not for construction techniques.

### Silk

Used on silk and wool fabrics, this strong, lustrous fiber is good for construction and decorative details such as buttonholes. Also used for machine and hand basting.



# bernette Presser Feet



Every machine needs a presser foot to hold the fabric in place against the feed dog, helping to move it under the needle for stitching. Along with an all-purpose foot for general sewing, other presser feet for specific tasks are included with bernette machines.

The presser feet are easy to attach with snap-on soles that take only a few seconds to change when needed. In addition to the standard presser feet included with each model, there are additional optional presser feet available for special techniques. For more information, go to <http://mybernette.com>.

## Standard Presser Feet



1. sew&go, b33 & b35



2. sew&go, b33 & b35



3. b33



4. b33 & b35



5. sew&go, b33 & b35



6. sew&go, b33 & b35



7. b35

**1. Zigzag Foot** – An all-purpose presser foot, the Zigzag Foot works well for most general sewing situations - seaming, topstitching, basting, gathering, etc., using the practical/utility stitches of the machines. Also useful for sewing open decorative stitches but heavy satin stitches may cause the foot to drag on the dense thread build-up.

**2. Zipper Foot** – This narrow foot lets the needle stitch next to the zipper coil. Place the edge of the foot next to the zipper coils and the needle stitches parallel to them.

**3. Satin Stitch Foot** – Intended for sewing over heavy decorative stitches such as satin stitches, the sole of this foot is designed to move easily over dense thread build-up.

**4. Blindstitch Foot** – Used with the blindstitch, this foot creates a hem that is inconspicuous from the right side of the fabric.

**5. Buttonhole Foot with Slide** – Required for creating functional and beautiful buttonholes for any project.

**6. Button-sew-on Foot** – This foot is designed to sit on top of a flat 2- or 4-hole button so it can easily be machine-stitched in place.

**7. Hemmer Foot** – The coil on the front of this foot holds the fabric edge in place for stitching, forming a double-turned narrow hem.

# Stitch Selection

## bernette Models: sew&go and b33

With the needle up, turn the stitch pattern selector knob so that the symbol with the desired stitch pattern points at the setting mark. Turn the stitch length knob to adjust the length; the higher the number, the longer the stitch length.



Stitch Pattern Selector knob

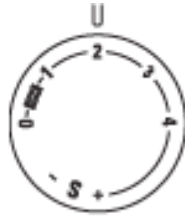

Stitch Length knob

To access the stretch stitches on the b33 (not available on the sew&go), turn the Stitch Length knob to "S". The stretch stitch patterns are shown on the machine in red. When the S is selected, the letters on the Stitch Pattern Selector knob will access the stretch stitches.

## bernette Model: b35

With the needle up, turn the stitch pattern selector knob so that the symbol with the desired stitch pattern points at the setting mark.

Turn the stitch length knob to adjust the length; the higher the number, the longer the stitch length.

Turn the stitch width knob to adjust the width; the higher the number, the wider the stitch length.

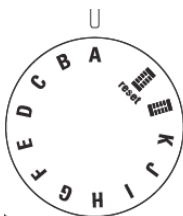

Stitch Pattern Selector knob

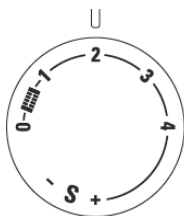

Stitch Length knob

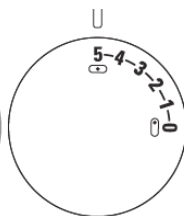

Stitch Width knob

## Helpful Basics

### Securing Stitches

Secure straight stitches using the reverse sewing feature. As long as the reverse sewing lever is depressed, the machine will sew in reverse.



### Thread Cutter

To cut the thread at the end of a seam, raise the presser foot and remove the fabric, pulling the threads towards the back. Go past the side thread cutter and then back over the top to cut the thread. The threads are now the proper length to begin sewing the next seam.







### Basting

Select the straight stitch and adjust the length to 4 mm - 5 mm. This forms a loose, long stitch that can temporarily hold fabrics together and easily be removed as needed.





# Turning Corners

-  Firm woven fabric, 4" x 6"
-  Lightweight tear-away stabilizer 4" x 6"
-  80/12 Universal
-  Center
-  Zigzag Foot

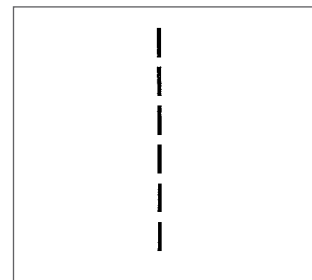

1. Select the Straight Stitch and adjust the stitch length to 2.5 mm.
2. Place the stabilizer on the wrong side of the fabric.
3. Sew a line of stitching and stop with the needle down in the fabric.
4. Raise the presser foot and pivot to turn a corner.
5. Lower the presser foot and continue sewing, pivoting to form at least 2-4 corners.

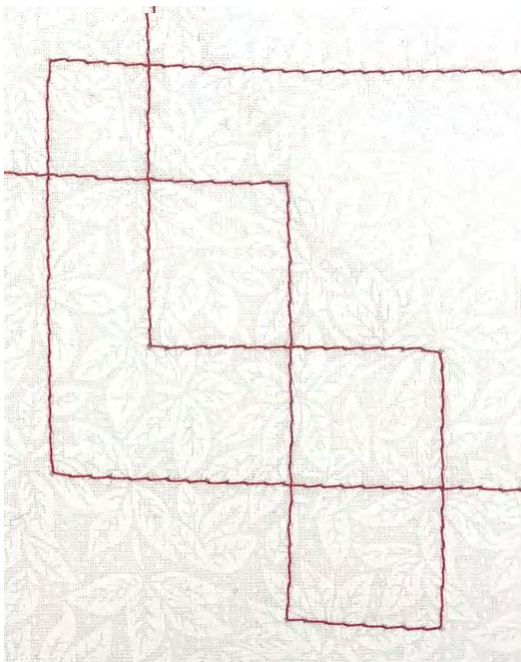

## Sew **HOW**

Do you know how to:

- Raise the presser foot of the machine?
- Pivot to form a stitched corner?

# Zigzag Stitch

 Firm woven fabric, 4" x 6"

 80/12 Universal

 As directed in instructions

 Zigzag Foot

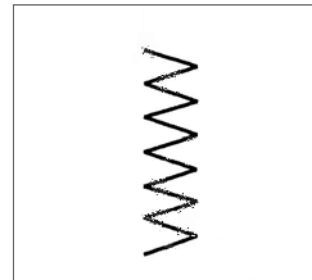

1. Select the Zigzag Stitch (width = 4, length = 2).
2. Finish one 6" edge using the following steps.
3. Align the edge of the fabric with inner toe of presser foot so stitch falls on edge of the fabric.
4. Sew using the inside edge of the right toe as a guide.
5. The needle should go into the fabric on one stroke of the needle and over the edge on the next stroke.

## Notes:

*The zigzag stitch makes a good finish for raw edges.*

*Do not use too long a stitch or too wide a stitch; the edge should lie flat, not roll.*

*Match the weight of the thread to the weight of the fabric for best results.*



## Sew HOW

Do you know how to:

- Adjust the stitch width?
- Adjust the stitch length?

# Blind Hem

-  Heavy flannel, 7" x 6"
-  80/12 Universal
-  As programmed
-  Zigzag Foot  
Blind Hem Foot

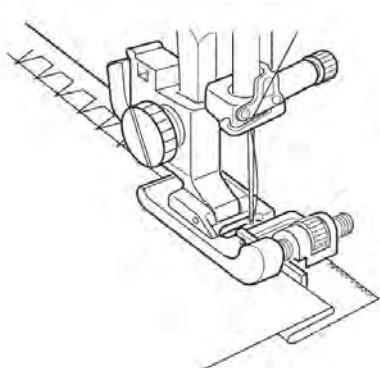
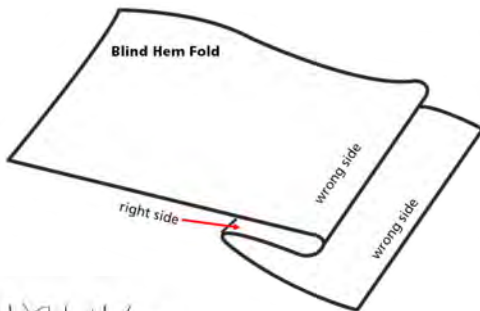
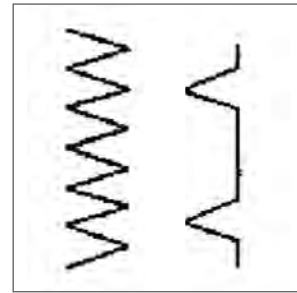

Blindstitch Foot is included with models b33 and b35. This foot can be purchased as an optional accessory for the sew&go model.







1. Attach Zigzag Foot to the machine.
2. Finish one 6" edge of the fabric using a zigzag stitch, guiding the edge of fabric under the center of the foot. The needle should go into the fabric on one stroke of the needle and over the edge on the next stroke.  
**Note:** *This is the same as the exercise on page 10.*
3. Fold a 2" hem to wrong side of fabric and press.
4. Baste the hem in place, sewing about 1/4" from the upper edge of the hem (the one previously stitched).
5. Select the Blindstitch and attach Blindstitch Foot to the machine.
6. Fold the hem back to the right side over the basting line, exposing the zigzagged edge of the fabric.
7. Place the folded fabric under the foot and position it so the needle sews on the extended hem allowance, barely stitching into the fold of the hem as it swings over.
8. Use the screw on the side of the foot to adjust the guide if needed so that it is next to the fold of the hem.
9. Sew the hem, keeping the fold of the fabric next to the guide.
9. Unfold the fabric when finished, and notice that the stitches barely show on the outside of the fabric.

## Sew HOW

Do you know how to:

- Machine baste?
- Do the blind hem fold?
- Adjust the guide on the Blindstitch Foot?

# 4-Step Buttonhole

-  Heavy flannel, 7" x 6"
-  Lightweight tear-away stabilizer 3.5" x 6"
-  80/12 Universal
-  As programmed
-  Buttonhole Foot

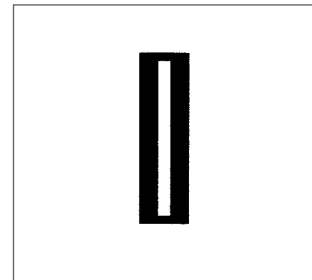

For Models sew&go and b33

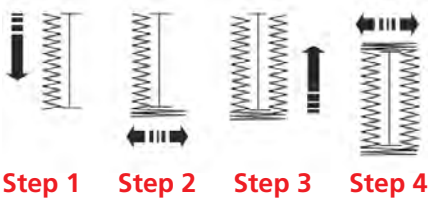
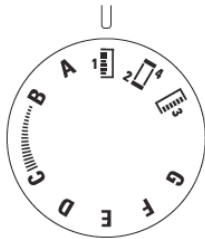

Step 1 Step 2 Step 3 Step 4

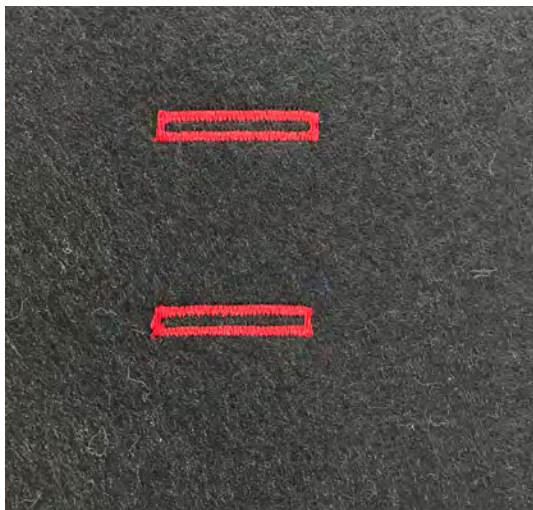





1. Fold flannel in half to 3.5" x 6" and press; insert stabilizer between the fabric layers.
2. Mark the beginning and ending points of the buttonhole on the fabric.
3. Select the Standard Buttonhole.
4. Attach the Buttonhole Foot. Move the slider of the foot so the upper marking on the slider is aligned with the marking for the starting position.
5. Align the markings on the foot with the upper marking on the fabric.
6. Turn the stitch pattern selector knob to Step 1.
7. Sew forwards until reaching the front marking on the fabric, stopping with the needle on the left.
8. Turn the stitch pattern selector knob to Step 2 and sew five stitches, stopping with the needle on the right.
9. Turn the stitch pattern selector knob to Step 3. Sew until you reach the rear marking of the buttonhole, stopping with the needle on the right.
10. Turn the stitch pattern selector knob to Step 4. Sew several bartacks and remove the needle from the fabric.
11. Set the stitch pattern selector knob to a straight stitch with a stitch length of "0". Sew several securing stitches to finish the buttonhole.

## Sew HOW

Do you know how to:

- Select a buttonhole?
- Stitch a buttonhole?

# 1-Step Buttonhole

-  Heavy flannel, 7" x 6"
-  Lightweight tear-away stabilizer 3.5" x 6"
-  80/12 Universal
-  As programmed
-  Buttonhole Foot with Slide

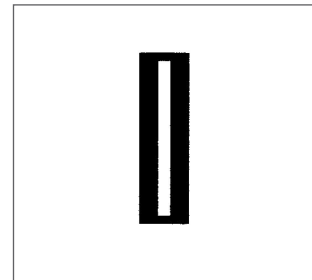

For Model b35

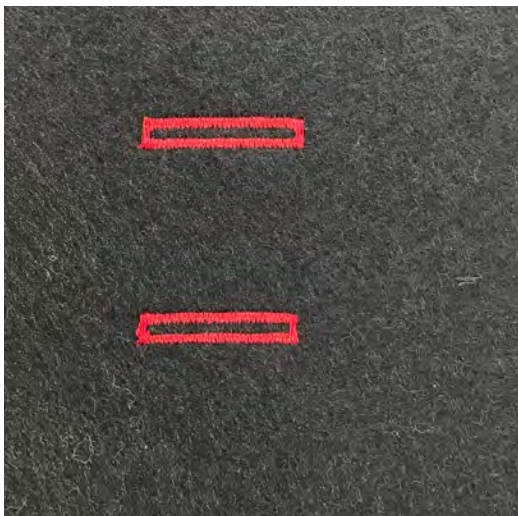
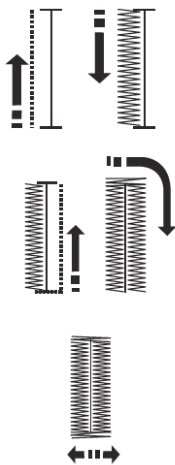







1. Fold flannel in half to 3.5" x 6" and press.
2. Insert stabilizer between the layers.
3. Mark buttonhole on fabric by drawing a line 1 1/2" from the fold along the 6" length. Mark the beginning point for each buttonhole along the drawn line.
4. Select the Standard buttonhole.
5. Press the needle stop up/down button to raise the needle.
6. Attach the Buttonhole Foot with Slide.
7. Pull the button holder to the back, and place the button in it. Push it together tightly against the button.
8. Pull buttonhole lever down as far as it will go.
9. Insert the corner of the fabric under the foot. Press the needle stop up/down button twice. Remove the fabric to the left to draw the needle thread through the hole of the foot.
10. Place the fabric under the foot, and lower the needle at the starting point of the buttonhole mark.
11. Lower the Buttonhole foot with slide. Start to sew, keeping the foot control depressed until buttonhole is complete (it will stitch following the steps shown in the diagram to the left).

## Sew HOW

Do you know how to:

- Select a buttonhole?
- Stitch a buttonhole?

# Attaching Buttons

-  Firm woven fabric, 4" x 6"
  -  Lightweight tear-away stabilizer 4" x 6"
  -  80/12 Universal
  -  As needed
  -  Button Sew-On Foot
  -  Feed dog lowered
- 3/4" (19 mm/30L) two-hole button**

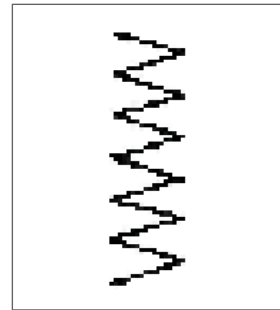

1. Attach the Button Sew-On Foot to the machine; adjusting the speed to slow.
2. Select the Zigzag stitch and lower the feed dog.
3. Place the stabilizer on the wrong side of the fabric.
4. Position fabric under the needle and place the button as desired. Lower the needle into one hole.
5. Check the distance between the holes of the button by turning the hand wheel. Adjust the stitch width if necessary so that the left and right swings of the needle fall into the holes of the button. Hold the thread tails as you begin to sew.
6. Sew 6-8 stitches, and stop. Bring the thread tails to the wrong side of the fabric and knot them together; trim the excess thread.

**Note:**

*Stitch bartacks to attach charms, snaps, hooks, eyes, and ribbons using the same technique described above.*

## Sew HOW

Do you know how to:

- Lower the feed dog?
- Use the Button Sew-On foot to sew bartack?

# Stitching Zippers

 Firm woven fabric, 4" x 6", two pieces

 80/12 Universal

 As programmed

 Zigzag Foot and Zipper Foot

4" to 7" neckline zipper

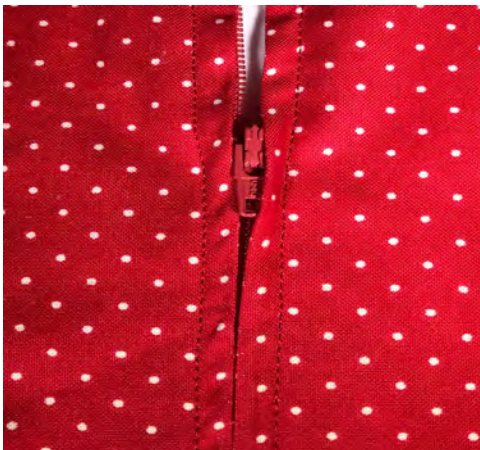
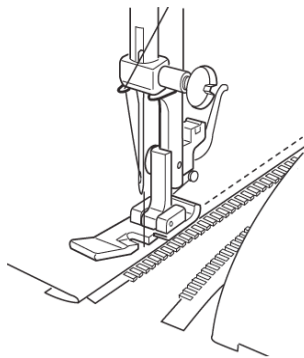
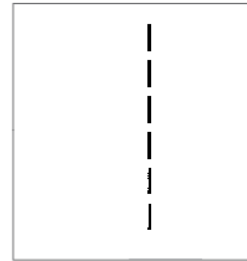

1. Attach Zigzag Foot to the machine.
2. Place fabric pieces right sides together.
3. Sew a straight stitch seam 3/4" from 6" edge:
  - Set stitch length at 2.5 mm. Start at one end and stitch for 2" (where zipper stop will be); backstitch to secure.
  - Change stitch length to a 4.0 mm stitch; baste the remainder of the seam.
  - Press seam allowances open.
4. Place the right side of the zipper against the seam allowances with the zipper teeth centered over the seam. Baste zipper to seam allowances only.
5. Attach Zipper Foot to the machine. Return the stitch length to 2.5 mm.
6. Sewing from the right side of the fabric, guide the edge of the foot beside the zipper teeth, stitching through the garment and zipper tape.
7. Turn the fabric and sew the other side of the zipper in the same way, pivoting at the lower edge to stitch across the zipper.
8. Remove the basting stitches.

## Sew HOW

Do you know how to:

- Machine baste a seam?
- Position the fabric under the foot to stitch close to the zipper coil?

# Decorative Stitching

## Decorative Stitching and Embellishment Techniques

As you begin to experiment with decorative stitches there are several things you should keep in mind:

- Type of thread you plan to use
- Presser foot you select
- How you prepare your fabric

### Type of Thread

Selecting the thread for decorative stitching often comes down to a personal preference and what looks best on your project.

Cotton embroidery thread, especially in a heavier weight such as 30, gives a beautiful look to the stitches and has a nice luster to it.

If you want a high sheen, rayon or polyester embroidery thread are good choices.

### Presser Foot

The presser foot you select is critical for good results because it can affect the way the fabric feeds under the needle, influencing the stitch formation.

Usually the key to selecting the correct presser foot is the sole. Stitches that are more open and have less thread will stitch well with an all-purpose presser foot such as the Zigzag foot.



When creating heavy, satin-stitched patterns, you will need a foot that is not flat on the bottom. It should have some type of indentation that allows the foot to ride over the completed stitch without dragging or inhibiting the feed of the fabric. The Satin Stitch foot and the Open Toe foot are designed for this purpose.



b33 & b35



b35

### Preparing the fabric





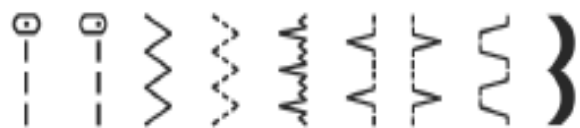
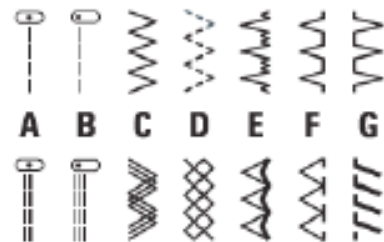
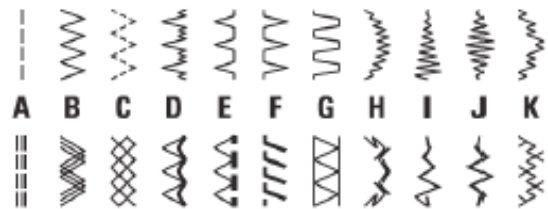

Preparing your fabric correctly can take the frustration out of stitching, giving you a positive experience with beautiful results. The fabric needs to be stable enough to support the stitching without tunneling or puckering. This can be accomplished in several ways, sometimes with a combination of techniques:

- The fabric itself might be heavy enough to support the stitching.
- Interfacing (fusible or sew-in) can be applied to the wrong side of the fabric and left in the project.
- Stabilizers are used as a temporary form of support.





# Satin Stitching

-  Firm woven fabric, 4" x 6"
-  Lightweight tear-away stabilizer 4" x 6"
-  80/12 Universal
-  Cotton or Polyester embroidery thread
-  As indicated in directions
-  Satin Stitch Foot or Open Toe Foot

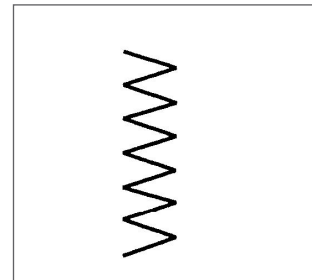

1. Attach a Satin Stitch or Open Toe foot to the machine. If neither of these feet is available, use a Zigzag Foot and set the stitch length slightly longer for a slightly more open stitch.
2. Place the stabilizer behind the fabric.
3. Select the Zigzag Stitch.
4. Adjust the stitch length to satin stitch (0.5mm) and the stitch width to 5-7 mm.
5. Stitch a line of satin stitching. This stitch is used as a fill stitch, for decorative edgings, and to stitch applique shapes to a background fabric.
6. Check the tension of the stitch; the needle thread should fall slightly to the wrong side of the fabric so that the bobbin thread does not show on the right side of the fabric. If needed, loosen the needle tension slightly to pull the thread to the wrong side.
7. Continue stitching while altering the stitch width for tapered effects.









## Sew HOW

Do you know how to:

- Select the settings for satin stitching?
- Taper and widen the satin stitch?

# Double Needle Stitching

-  Firm woven fabric, 4" x 6"
-  Lightweight tear-away stabilizer 4" x 6"
-  2.0 mm or 3.0mm Double Needle
-  Two spools of cotton or polyester embroidery thread
-  Center
-  Zigzag or Satin Stitch Foot

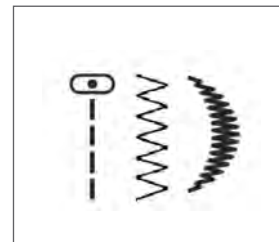

Double Needles are available in sizes: 1.6/70 to 8.0/100

*Note: Do not use a twin needle with spacing wider than the maximum stitch width of the machine.*



1. Attach a Zigzag or Satin Stitch foot to the machine.
2. Place the stabilizer behind the fabric.
3. Insert the Double Needle into the machine with the flat side to the back.
4. Thread the machine with 2 spools of thread following the normal thread path. When you reach the last thread guide before the needle, place one thread in it and bypass it with the second thread. Separating the threads before threading the needles will help keep the threads from tangling as you sew.
5. Carefully check the stitch width before sewing to avoid breaking the needles; turn the handwheel to walk the machine through the first stitch.
6. Select several different stitches and sew parallel lines of double stitches as shown.

### Double Needle Tips

- When doing decorative needle work, sew slowly – change motor to half speed if this option is available.
- Use this formula to determine the widest stitch width possible before the needle strikes the presser foot:  
**Widest width of the machine minus the width between the two needles = widest stitch width possible.**

Do you know how to: **Sew HOW**

- Insert a Double Needle?
- Thread the machine for Double Needle sewing?



# SUPPLIES

Q.	FABRIC TYPE	SIZE	EXERCISES	EXAMPLES
8	Firm woven	4" x 6"	Turning Corners, pg. 9 Zigzag Stitch, pg. 10 Attaching Buttons, pg. 14 Satin Stitching, pg. 17 Stitching Zippers, pg. 15 Double Needle Stitching, pg. 18	Heavy muslin High-quality quilting cotton Medium weight denim
2	Heavy Flannel	7" x 6"	Blind Hem, pg. 11 Buttonholes, page 12 or 13	Wool flannel Brushed denim

NOTION OR ACCESSORY	EXERCISES
One piece of lightweight tear-away stabilizer, 3.5" x 6"	Buttonholes, pgs. 12 or 13
Optional: Buttonhole Cutter and Block	Buttonholes, pgs. 12 or 13
Three pieces of lightweight tear-away stabilizer, 4" x 6"	Attaching Buttons, pg. 14 Satin Stitching, pg. 17 Double Needle Stitching, pg. 18
Two-three flat, 2- and 4-hole buttons	Attaching Buttons, page 14
4"-7" neckline zipper	Stitching Zippers, pg. 15

NEEDLES & THREADS	
80/12 Universal (Ballpoint may be used for knit fabrics)	For all stitch exercises except Double Needle Stitching
Double Needle, size 2.0mm or 3.0mm	Double Needle Stitching, pg. 22
Cotton or Polyester	For all stitch exercises

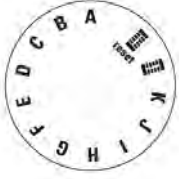
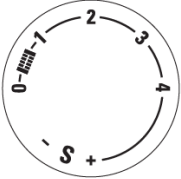
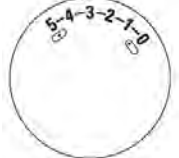
## SEWING FUNCTIONS

	<p><b>Stitch Pattern Selector Knob</b></p>		<p><b>Stitch Length Knob</b></p> <ul style="list-style-type: none"> <li>• Turn between 0-4 to adjust stitch length</li> <li>• Turn the knob to "S" to sew stretch stitch patterns. Condense or expand with the "-" or "+".</li> </ul>
	<p><b>Stitch Width Knob</b></p> <ul style="list-style-type: none"> <li>• When straight stitch selected, needle position will move from positions 0-5</li> </ul>		<p><b>Reverse Sewing Lever</b></p>

## STITCH CHART

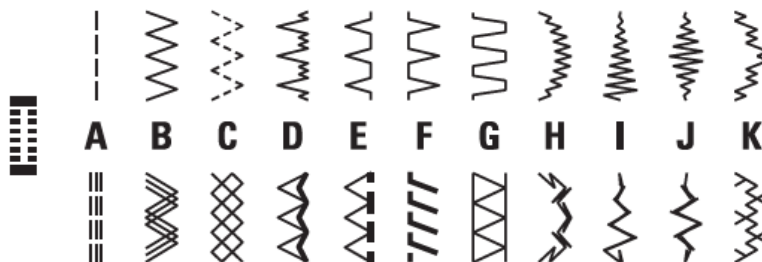

# bernette 35 Accessories

### 7 Presser Feet:

*One shank + 7 snap-on soles:*

- Zigzag Foot
- Satin Stitch Foot
- Zipper Foot
- Hemmer Foot
- Button Sew-on Foot
- Blindstitch Foot
- Buttonhole Foot with Slide



### Additional Accessories:

- Manual
- 4 Bobbins
- 1 pkg. Assorted Needles
- Seam Ripper
- Large Screwdriver
- Small Screwdriver
- Oiler

### WARRANTY

- 2 years Electrical
- 10 years Mechanical
- 2 years Electronic

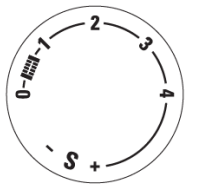
## SEWING FUNCTIONS

	<p><b>Stitch Pattern Selector Knob</b></p>		<p><b>Stitch Length Knob</b></p> <ul style="list-style-type: none"> <li>Turn between 0-4 to adjust stitch length</li> <li>Turn the knob to "S" to sew stretch stitch patterns. Condense or expand with the "-" or "+".</li> </ul>
	<p><b>Reverse Sewing Lever</b></p>		

## STITCH CHART

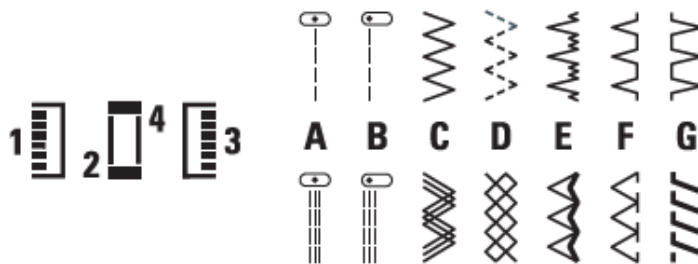

# bernette 33 Accessories

### 5 Presser Feet:

*One shank + 5 snap-on soles:*

- Zigzag Foot
- Buttonhole Foot with Slide
- Blindstitch Foot
- Zipper Foot
- Button Sew-on Foot

### Additional Accessories:

- Manual
- 3 Bobbins
- 1 pkg. Assorted Needles
- Seam Ripper
- Oiler Pen



### Optional:

- Dust Cover

### WARRANTY

- 2 years Electrical
- 10 years Mechanical
- 2 years Electronic

## SEWING FUNCTIONS

	<b>Stitch Pattern Selector Knob</b>		<b>Stitch Length Knob</b> <ul style="list-style-type: none"> <li>Turn between 0-4 to adjust stitch length</li> <li>Turn the knob to "S" to sew stretch stitch patterns. Condense or expand with the "-" or "+".</li> </ul>
	<b>Reverse Sewing Lever</b>		

## STITCH CHART



# bernette sew&go 1 Accessories

### 5 Presser Feet:

*One shank + 4 snap-on soles:*

- Zigzag Foot
- Zipper Foot
- Buttonhole Foot
- Button sew-on Foot

### Additional Accessories:

- Manual
- 3 Bobbins
- 1 pkg. Assorted Needles
- Brush and Seam Ripper
- Right Seam Guide
- Large Spool Holder
- Small Spool Holder
- L Scredriver
- Oiler Pen
- Darning Plate
- Vertical Spool Pin
- Spool Pin Felt

### WARRANTY

- 10 years Mechanical
- 2 years Electrical
- 2 years Electronic